



正基科技股份有限公司

# SPECIFICATION

SPEC. NO. : \_\_\_\_\_ REV : \_\_\_\_\_ 1.1

DATE : \_\_\_\_\_ 12. 26. 2012

PRODUCT NAME : \_\_\_\_\_ **AP6181**

	APPROVED	CHECKED	PREPARED	DCC ISSUE
NAME				

# AMPAK

## AP6181

Wi-Fi 802.11b/g/n  
SIP Module Spec Sheet

# Revision History

Date	Revision Content	Revised By	Version
2012/10/01	- Initial released	Joe	1.0
2012/12/26	- Modify Pin name 29,30	Brian	1.1

AMPAK  
Confidential

# Contents

<b>Revision History</b> .....	<b>1</b>
<b>Contents</b> .....	<b>2</b>
<b>1. Introduction</b> .....	<b>3</b>
<b>2. Features</b> .....	<b>4</b>
<b>3. Deliverables</b> .....	<b>5</b>
3.1 Deliverables.....	5
3.2 Regulatory certifications .....	5
<b>4. General Specification</b> .....	<b>6</b>
4.1 Wi-Fi RF Specification .....	6
4.2 Voltages.....	7
4.2.1 Absolute Maximum Ratings.....	7
4.2.2 Recommended Operating Ratings .....	7
<b>5. Pin Assignments</b> .....	<b>8</b>
5.1 PCB Pin Outline.....	8
5.2 Pin Definition .....	8
<b>6. Dimensions</b> .....	<b>10</b>
6.1 Physical Dimensions.....	10
6.2 Recommended Footprint .....	11
<b>7. External clock reference</b> .....	<b>12</b>
7.1 SDIO Pin Description.....	12
<b>8. Host Interface Timing Diagram</b> .....	<b>13</b>
8.1 Power-up Sequence Timing Diagram .....	13
8.2 SDIO Default Mode Timing Diagram .....	14
8.3 SDIO High Speed Mode Timing Diagram .....	15
<b>9. Recommended Reflow Profile</b> .....	<b>16</b>
<b>10. Packing Information</b> .....	<b>17</b>
10.1 Label.....	17
10.2 Dimension.....	18
10.3 MSL Level / Storage Condition .....	20

# 1. Introduction

AMPAK Technology would like to announce a low-cost and low-power consumption module which has all of the Wi-Fi functionalities. The highly integrated module makes the possibilities of web browsing, VoIP, headsets and other applications. With seamless roaming capabilities and advanced security, also could interact with different vendors' 802.11b/g/n Access Points in the wireless LAN.

This wireless module complies with IEEE 802.11 b/g/n standard and it can achieve up to a speed of 72.2Mbps with single stream in 802.11n draft, 54Mbps as specified in IEEE 802.11g, or 11Mbps for IEEE 802.11b to connect to the wireless LAN. The integrated module provides SDIO interface for Wi-Fi.

This compact module is a total solution for Wi-Fi technologies. The module is specifically developed for Tablet, Smart phones and Portable devices.

## 2. Features

- Single-band 2.4GHz IEEE 802.11b/g/n
- Supports standard interfaces SDIO v2.0(50MHz, 4-bit and 1-bit)
- Integrated ARM Cortex-M3™ CPU with on-chip memory enables running IEEE802.11 firmware that can be field-upgraded with future features.
- Security:
  - i. Hardware WAPI acceleration engine
  - ii. AES and TKIP in hardware for faster data encryption and IEEE 802.11i compatibility
  - iii. WPA™ – and WPA2™ - (Personal) support for powerful encryption and authentication

A simplified block diagram of the module is depicted in the figure below.

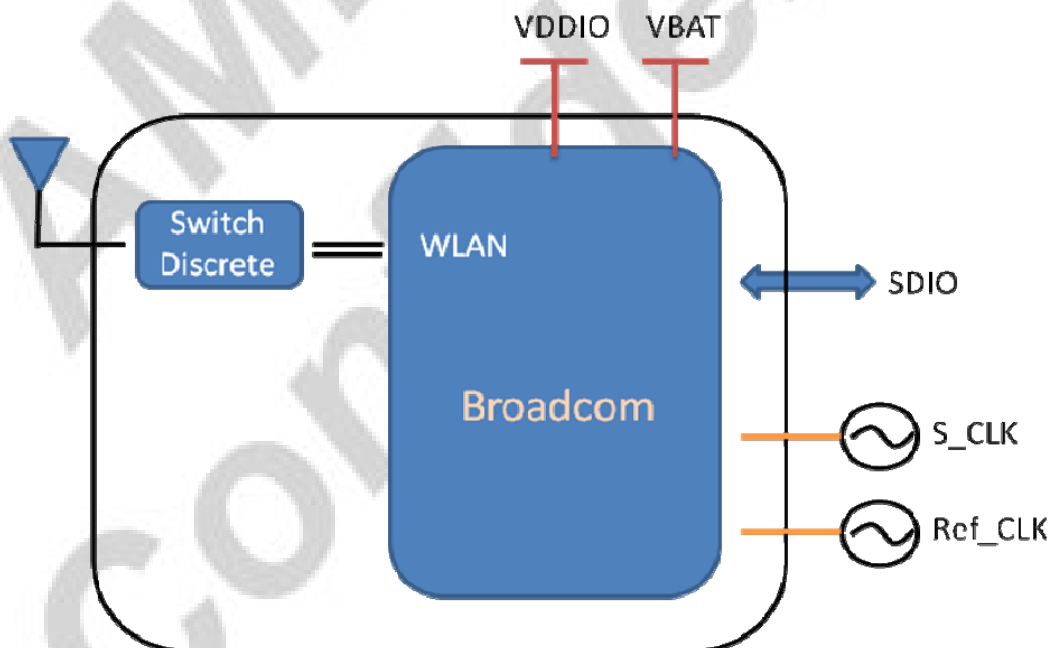

## 3. Deliverables

### 3.1 Deliverables

The following products and software will be part of the product.

- Module with packaging
- Evaluation Kits
- Software utility for integration, performance test.
- Product Datasheet.
- Agency certified pre-tested report with the adapter board.

### 3.2 Regulatory certifications

The product delivery is a pre-tested module, without the module level certification. For module approval, the platform's antennas are required for the certification.

## 4. General Specification

### 4.1 Wi-Fi RF Specification

Conditions : VBAT=3.6V ; VDDIO=3.3V ; Temp:25°C

Feature	Description
Model Name	AP6181
WLAN Standard	IEEE 802.11b/g/n, WiFi compliant
Host Interface	SDIO
Dimension	L x W x H: 12 x 12 x 1.5 (typical) mm
Frequency Range	2.412 GHz ~ 2.4835 GHz (2.4 GHz ISM Band)
Number of Channels	11 for North America, 13 for Europe, and 14 for Japan
Modulation	802.11b : DQPSK, DBPSK, CCK 802.11g/n : OFDM /64-QAM, 16-QAM, QPSK, BPSK
Output Power	802.11b /11Mbps : 16 dBm $\pm$ 1.5 dB @ EVM $\leq$ -9dB
	802.11g /54Mbps : 15 dBm $\pm$ 1.5 dB @ EVM $\leq$ -25dB
	802.11n /65Mbps : 14 dBm $\pm$ 1.5 dB @ EVM $\leq$ -28dB
Receive Sensitivity (11n,20MHz) @10% PER	- MCS=0 PER @ -85 $\pm$ 1dBm, typical
	- MCS=1 PER @ -84 $\pm$ 1dBm, typical
	- MCS=2 PER @ -82 $\pm$ 1dBm, typical
	- MCS=3 PER @ -80 $\pm$ 1dBm, typical
	- MCS=4 PER @ -77 $\pm$ 1dBm, typical
	- MCS=5 PER @ -73 $\pm$ 1dBm, typical
	- MCS=6 PER @ -71 $\pm$ 1dBm, typical
Receive Sensitivity (11g) @10% PER	- 6Mbps PER @ -87 $\pm$ 1dBm, typical
	- 9Mbps PER @ -86 $\pm$ 1dBm, typical
	- 12Mbps PER @ -85 $\pm$ 1dBm, typical
	- 18Mbps PER @ -83 $\pm$ 1dBm, typical
	- 24Mbps PER @ -81 $\pm$ 1dBm, typical
	- 36Mbps PER @ -78 $\pm$ 1dBm, typical
	- 48Mbps PER @ -74 $\pm$ 1dBm, typical
Receive Sensitivity (11b) @8% PER	- 1Mbps PER @ -90 $\pm$ 1dBm, typical
	- 2Mbps PER @ -89 $\pm$ 1dBm, typical
	- 5.5Mbps PER @ -87 $\pm$ 1dBm, typical
	- 11Mbps PER @ -84 $\pm$ 1dBm, typical



Data Rate	802.11b : 1, 2, 5.5, 11Mbps
	802.11g : 6, 9, 12, 18, 24, 36, 48, 54Mbps
Data Rate (20MHz ,Long GI,800ns)	802.11n: 6.5, 13, 19.5, 26, 39, 52, 58.5, 65Mbps
Data Rate (20MHz ,short GI,400ns)	802.11n : 7.2, 14.4, 21.7, 28.9, 43.3, 57.8, 65,72.2Mbps
Maximum Input Level	802.11b : -10 dBm
	802.11g/n : -20 dBm
Operating temperature	-30°C to 85°C
Storage temperature	-40°C to 85°C
Humidity	Operating Humidity 10% to 95% Non-Condensing Storage Humidity 5% to 95% Non-Condensing

## 4.2 Voltages

### 4.2.1 Absolute Maximum Ratings

Symbol	Description	Min.	Max.	Unit
VBAT	Input supply Voltage	-0.5	6.5	V
VDDIO	Digital/Bluetooth/SDIO Voltage	-0.5	4.1	V

### 4.2.2 Recommended Operating Ratings

Test conditions: At room temperature 25°C				
Symbol	Min.	Typ.	Max.	Unit
VBAT	3.0	3.6	4.8	V
VDDIO	1.71	-	3.6	V

Note: The voltage of VDDIO is depended on system I/O voltage.

Test conditions: At operating temperature -10°C ~65°C				
Symbol	Min.	Typ.	Max.	Unit
VBAT	3.0	3.6	4.8	V
VDDIO	1.71	-	3.6	V

Note: VDDIO operating voltage range from 1.71V to 3.63V at operating temperature is guaranteed.

# 5. Pin Assignments

## 5.1 PCB Pin Outline

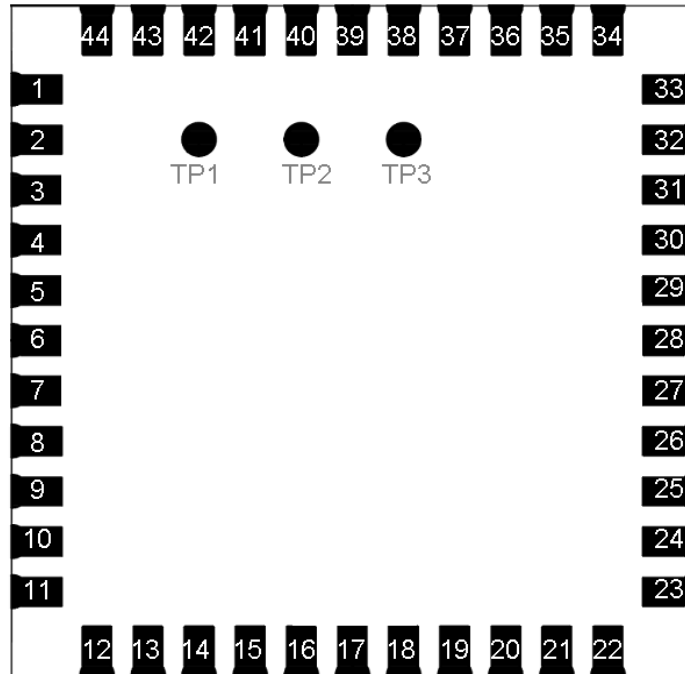

< TOP VIEW >

## 5.2 Pin Definition

NO	Name	Type	Description
1	GND	—	Ground connections
2	WL_BT_ANT	I/O	RF I/O port
3	GND	—	Ground connections
4	NC	—	Floating (Don't connected to ground)
5	NC	—	Floating (Don't connected to ground)
6	NC	—	Floating (Don't connected to ground)
7	NC	—	Floating (Don't connected to ground)
8	NC	—	Floating (Don't connected to ground)
9	VBAT	P	Main power voltage source input
10	XTAL_IN	I	XTAL oscillator input
11	XTAL_OUT	O	XTAL oscillator output
12	WL_REG_ON	I	Internal regulators power enable/disable
13	WL_HOST_WAKE	O	WLAN wake-up HOST
14	SDIO_DATA_2	I/O	SDIO data line 2
15	SDIO_DATA_3	I/O	SDIO data line3

16	SDIO_DATA_CMD	I/O	SDIO command line
17	SDIO_DATA_CLK	I/O	SDIO CLK line
18	SDIO_DATA_0	I/O	SDIO data line 0
19	SDIO_DATA_1	I/O	SDIO data line 1
20	GND	—	Ground connections
21	VIN_LDO_OUT	P	Internal Buck voltage generation pin
22	VDDIO	P	I/O Voltage supply input
23	VIN_LDO	P	Internal Buck voltage generation pin
24	LPO	I	External Low Power Clock input (32.768KHz)
25	NC	—	Floating (Don't connected to ground)
26	NC	—	Floating (Don't connected to ground)
27	NC	—	Floating (Don't connected to ground)
28	NC	—	Floating (Don't connected to ground)
29	NC	—	Floating (Don't connected to ground)
30	NC	—	Floating (Don't connected to ground)
31	GND	—	Ground connections
32	NC	—	Floating (Don't connected to ground)
33	GND	—	Ground connections
34	NC	—	Floating (Don't connected to ground)
35	NC	—	Floating (Don't connected to ground)
36	GND	—	Ground connections
37	NC	—	Floating (Don't connected to ground)
38	NC	—	Floating (Don't connected to ground)
39	NC	—	Floating (Don't connected to ground)
40	NC	—	Floating (Don't connected to ground)
41	NC	—	Floating (Don't connected to ground)
42	NC	—	Floating (Don't connected to ground)
43	NC	—	Floating (Don't connected to ground)
44	NC	—	Floating (Don't connected to ground)
45	TP1 (NC)	—	Floating (Don't connected to ground)
46	TP2 (NC)	—	Floating (Don't connected to ground)
47	TP3 (NC)	—	Floating (Don't connected to ground)

# 6. Dimensions

## 6.1 Physical Dimensions

(Unit: mm)

< TOP VIEW >

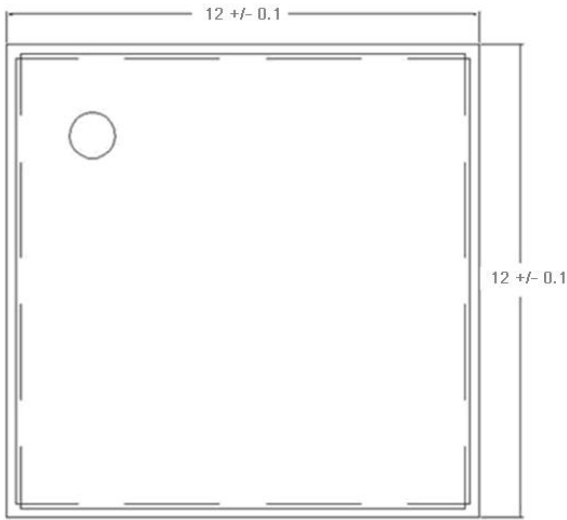

< Side View >

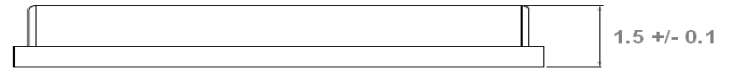

< TOP VIEW >

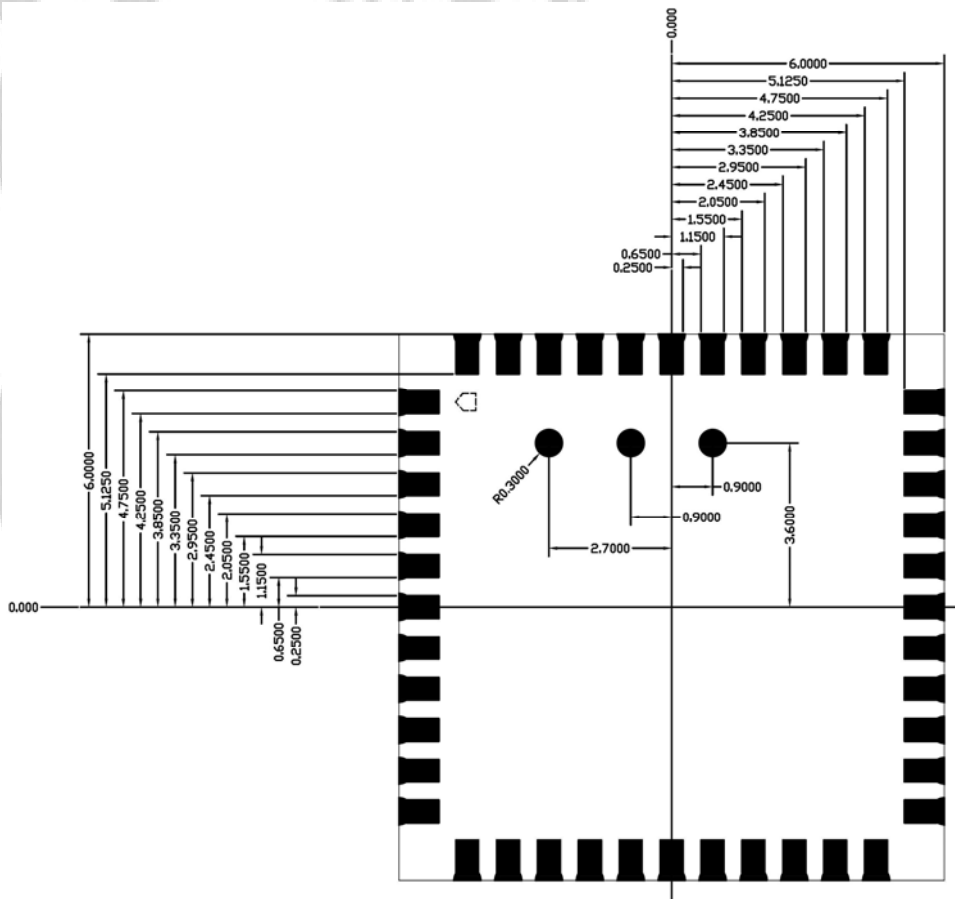

## 6.2 Recommended Footprint

(Unit: mm)

< TOP VIEW >

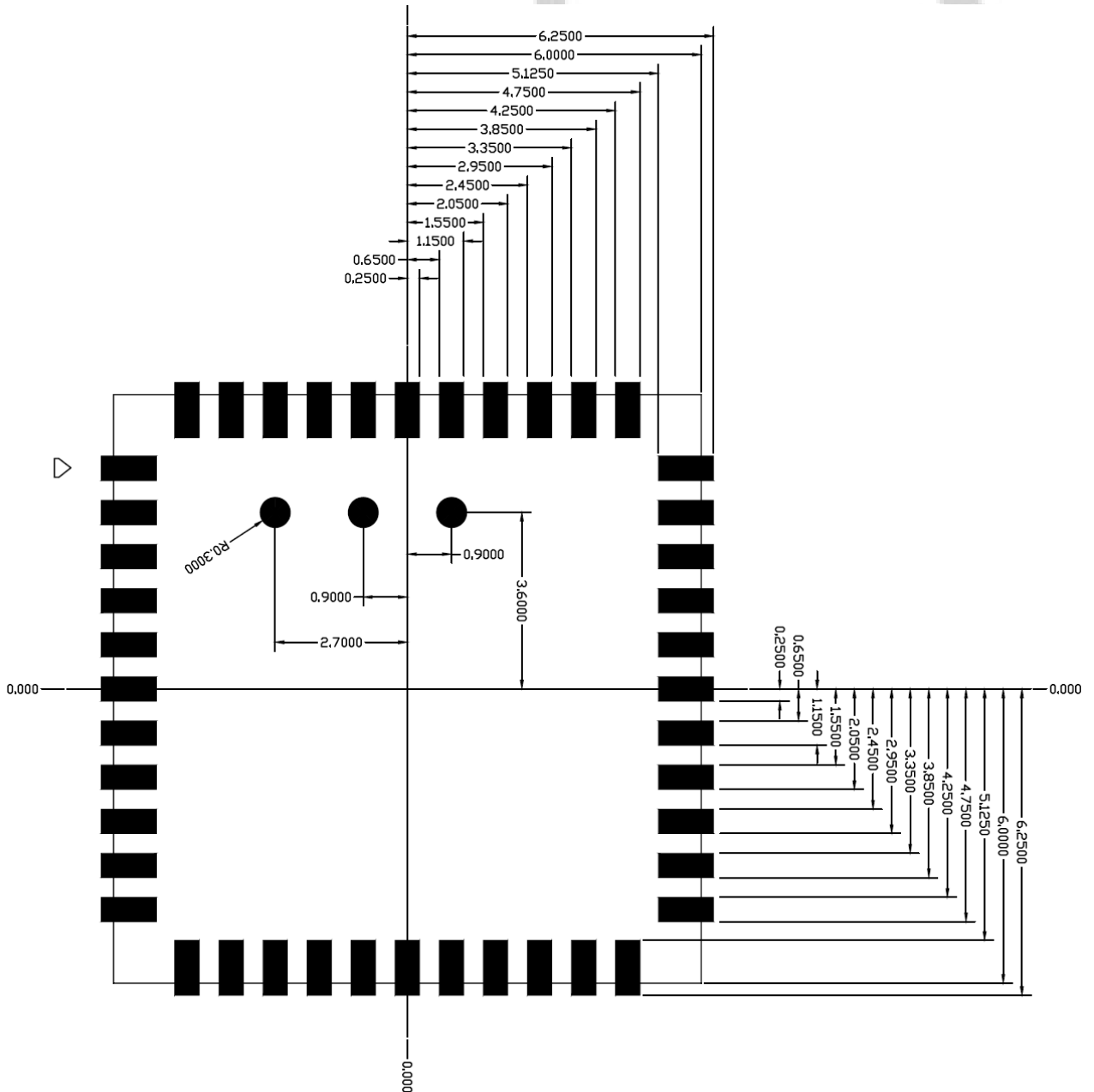

## 7. External clock reference

### External LPO signal characteristics

Parameter	LPO Clock	Units
Nominal input frequency	32.768	kHz
Frequency accuracy	± 30	ppm
Duty cycle	30 - 70	%
Input signal amplitude	1600 to 3300	mV, p-p
Signal type	Square-wave or sine-wave	-
Input impedance	>100k	Ω
	<5	pF
Clock jitter (integrated over 300Hz – 15KHz)	<1	Hz

### External Ref\_CLK signal characteristics

No.	Item	Symb.	Electrical Specification				Remark
			Min.	Type	Max.	Units	
1	Nominal Frequency	F0	26.00000			MHz	
2	Mode of Vibration		Fundamental				
3	Frequency Tolerance	$\Delta F/F0$	-10	-	10	ppm	at 25°C±3°C
4	Operating Temperature Range	T <sub>OPR</sub>	-30	-	85	°C	
5	Frequency Stability	TC	-10	-	10	ppm	
6	Storage Temperature	T <sub>STG</sub>	-55	-	125	°C	
7	Load capacitance	CL	-	16		pF	
8	Equivalent Series Resistance	ESR	-	-	50	Ω	
9	Drive Level	DL	-	100	200	μW	
10	Insulation Resistance	IR	500	-	-	MΩ	At 100V <sub>DC</sub>
11	Shunt Capacitance	C0	-	-	3	pF	
12	Aging Per Year	Fa	-2	-	2	ppm	First Year

### 7.1 SDIO Pin Description

The module supports SDIO version 2.0 for 4-bit modes. It has the ability to stop the SDIO clock and map the interrupt signal into a GPIO pin. This 'out-of-band' interrupt signal notifies the host when the WLAN device wants to turn on the SDIO interface. The ability to force the control of the gated clocks from within the WLAN chip is also provided.

- ❖ Function 0 Standard SDIO function (Max BlockSize / ByteCount = 32B)
- ❖ Function 1 Backplane Function to access the internal System On Chip (SOC) address space (Max BlockSize / ByteCount = 64B)
- ❖ Function 2 WLAN Function for efficient WLAN packet transfer through DMA (Max BlockSize/ByteCount=512B)

## SDIO Pin Description

SD 4-Bit Mode	
DATA0	Data Line 0
DATA1	Data Line 1 or Interrupt
DATA2	Data Line 2 or Read Wait
DATA3	Data Line 3
CLK	Clock
CMD	Command Line

# 8. Host Interface Timing Diagram

## 8.1 Power-up Sequence Timing Diagram

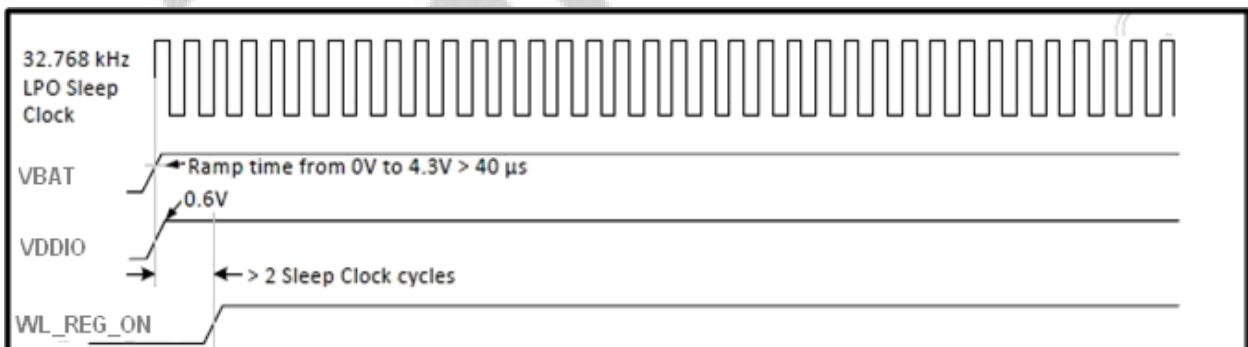

- ❖ WL\_REG\_ON: Internal regulators power enable/disable. This pin must be driven high or low (not left floating).

## 8.2 SDIO Default Mode Timing Diagram

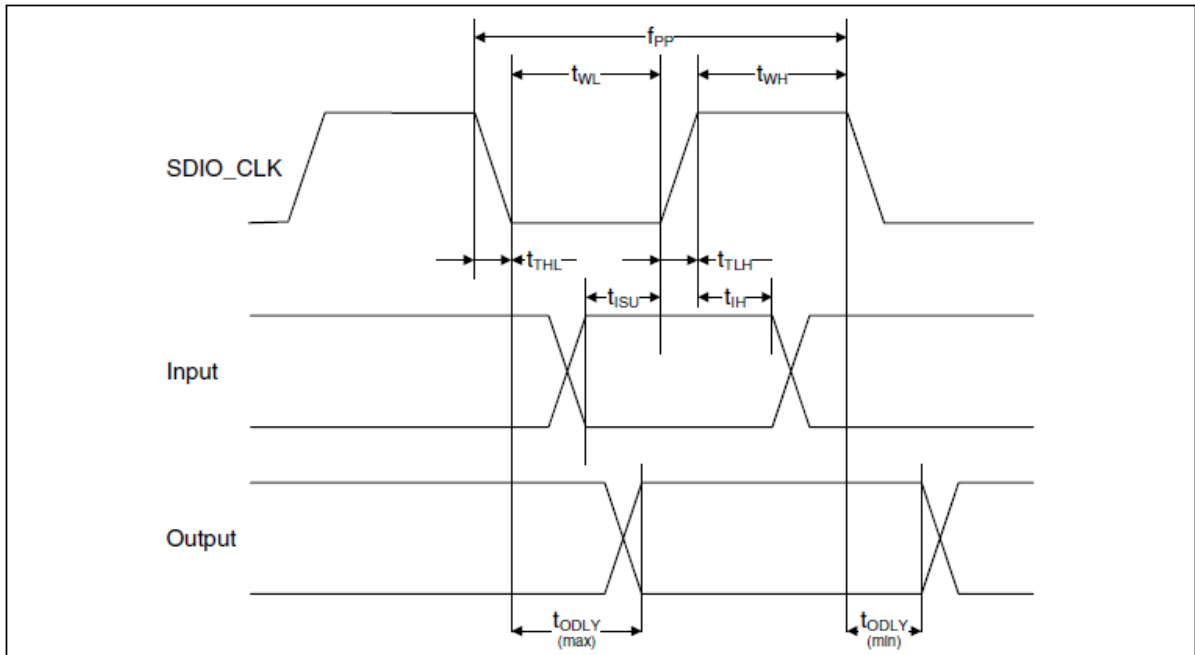

Parameter	Symbol	Minimum	Typical	Maximum	Unit
<b>SDIO CLK (All values are referred to minimum VIH and maximum VIL<sup>b</sup>)</b>					
Frequency-Data Transfer mode	f <sub>PP</sub>	0	-	25	MHz
Frequency-Identification mode	f <sub>OD</sub>	0	-	400	kHz
Clock low time	t <sub>WL</sub>	10	-	-	ns
Clock high time	t <sub>WH</sub>	10	-	-	ns
Clock rise time	t <sub>TLH</sub>	-	-	10	ns
Clock low time	t <sub>TLL</sub>	-	-	10	ns
<b>Inputs: CMD, DAT (referenced to CLK)</b>					
Input setup time	t <sub>ISU</sub>	5	-	-	ns
Input hold time	t <sub>IH</sub>	5	-	-	ns
<b>Outputs: CMD, DAT (referenced to CLK)</b>					
Output delay time - Data Transfer mode	t <sub>ODLY</sub>	0	-	14	ns
Output delay time - Identification mode	t <sub>ODLY</sub>	0	-	50	ns

a. Timing is based on CL ≤ 40pF load on CMD and Data.

b. min(V<sub>Ih</sub>) = 0.7 × V<sub>DDIO</sub> and max(V<sub>Il</sub>) = 0.2 × V<sub>DDIO</sub>.



### 8.3 SDIO High Speed Mode Timing Diagram

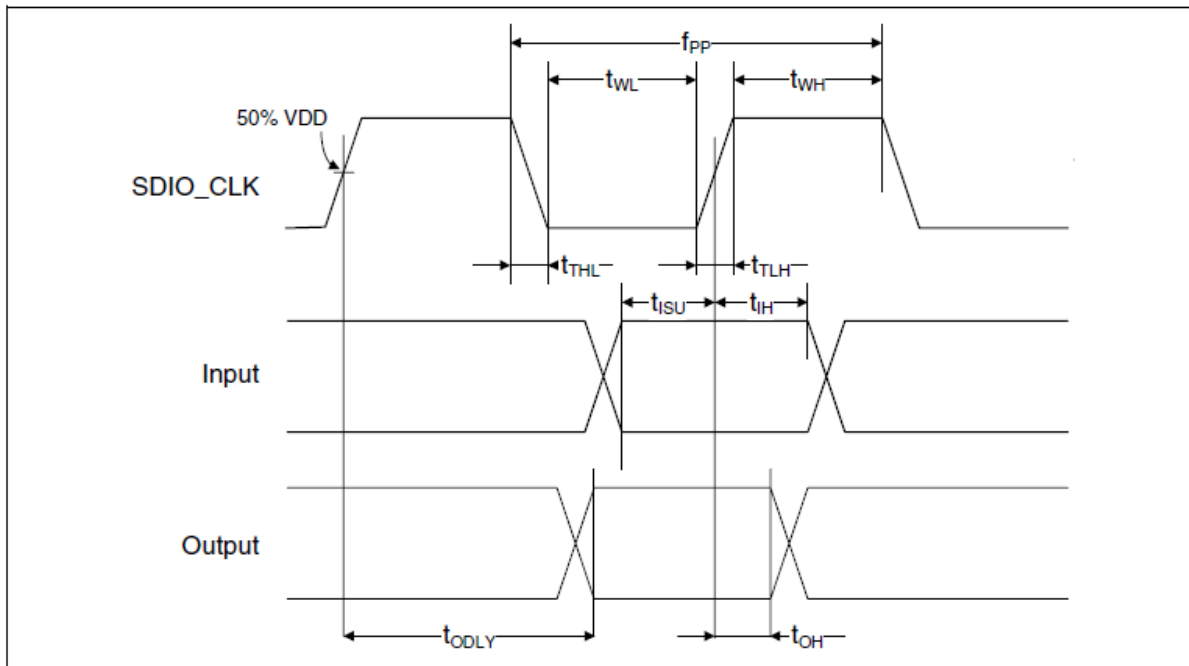

Parameter	Symbol	Minimum	Typical	Maximum	Unit
<b>SDIO CLK (All values are referred to minimum VIH and maximum VIL<sup>b</sup>)</b>					
Frequency-Data Transfer mode	f <sub>PP</sub>	0	-	50	MHz
Frequency-Identification mode	f <sub>OD</sub>	0	-	400	kHz
Clock low time	t <sub>WL</sub>	7	-	-	ns
Clock high time	t <sub>WH</sub>	7	-	-	ns
Clock rise time	t <sub>TLH</sub>	-	-	3	ns
Clock low time	t <sub>TLH</sub>	-	-	3	ns
<b>Inputs: CMD, DAT (referenced to CLK)</b>					
Input setup time	t <sub>ISU</sub>	6	-	-	ns
Input hold time	t <sub>IH</sub>	2	-	-	ns
<b>Outputs: CMD, DAT (referenced to CLK)</b>					
Output delay time - Data Transfer mode	t <sub>ODLY</sub>	-	-	14	ns
Output hold time	t <sub>OH</sub>	2.5	-	-	ns
Total system capacitance (each line)	CL	-	-	40	pF

a. Timing is based on CL ≤ 40pF load on CMD and Data.

b. min(V<sub>Ih</sub>) = 0.7 x VDDIO and max(V<sub>Il</sub>) = 0.2 x VDDIO.

# 9. Recommended Reflow Profile

Referred to IPC/JEDEC standard.

Peak Temperature : <250°C

Number of Times :  $\leq 2$  times

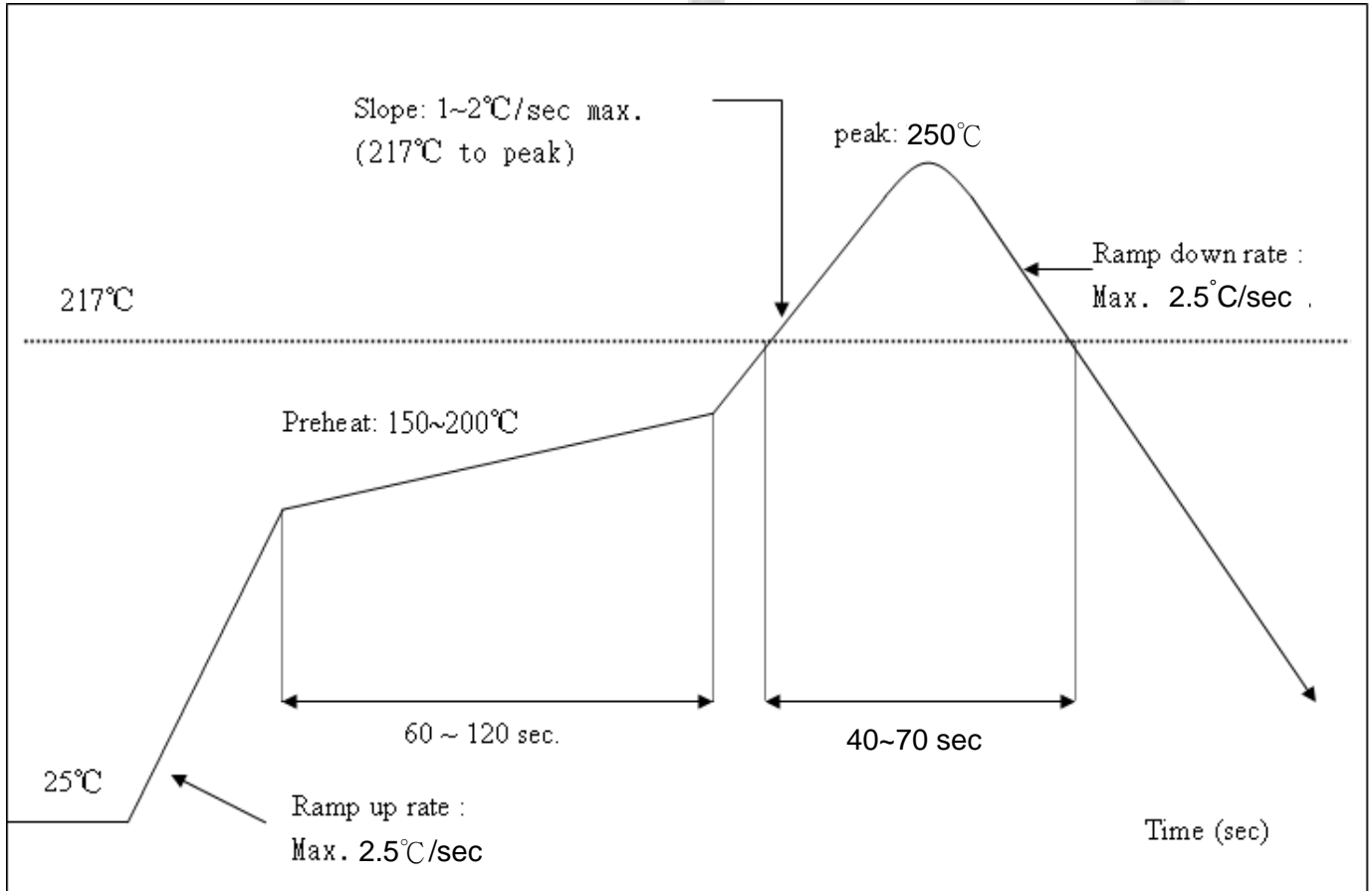

# 10. Packing Information

## 10.1 Label

Label A → Anti-static and humidity notice

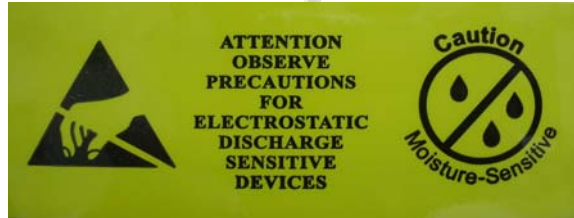





Label B → MSL caution / Storage Condition

	<b>Caution</b>	LEVEL
	This bag contains MOISTURE-SENSITIVE DEVICES	
<small>If blank, see adjacent bar code label</small>		
1. Calculated shelf life in sealed bag: 12 months at <math> <40^{\circ}\text{C}</math> and <math> <90\%</math> relative humidity (RH)		
2. Peak package body temperature: _____ $^{\circ}\text{C}$ <small>If blank, see adjacent bar code label</small>		
3. After bag is opened, devices that will be subjected to reflow solder or other high temperature process must be		
a) Mounted within: _____ hours of factory conditions <small>If blank, see adjacent bar code label</small>		
<math> <30^{\circ}\text{C}/60\%</math> RH, or		
b) Stored per J-STD-033		
4. Devices require bake, before mounting, if:		
a) Humidity Indicator Card reads >10% for level 2a - 5a devices or >60% for level 2 devices when read at <math> 23 \pm 5^{\circ}\text{C}</math>		
b) 3a or 3b are not met		
5. If baking is required, refer to IPC/JEDEC J-STD-033 for bake procedure		
Bag Seal Date: _____ <small>If blank, see adjacent bar code label</small>		
<small>Note: Level and body temperature defined by IPC/JEDEC J-STD-020</small>		

Label C → Inner box label .

PKG S/N :	
	9PKG12013100001
Model:	
	XXXXXXXX(HF)
P/N :	
	99P-W01-0042R
Qty :	
	1500
Date Code :	
	1205
Lot Code :	
	T0C102B

Label D → Carton box label .

<b>AMPAK Technology</b>	
Model Name :	
	XXXXXXXX(HF)
Part No :	
	99P-W01-0042R
Quantity :	
	7500 ea
Lot D/C :	
	1205
Manufacture :	
	2012/02/22

## 10.2 Dimension

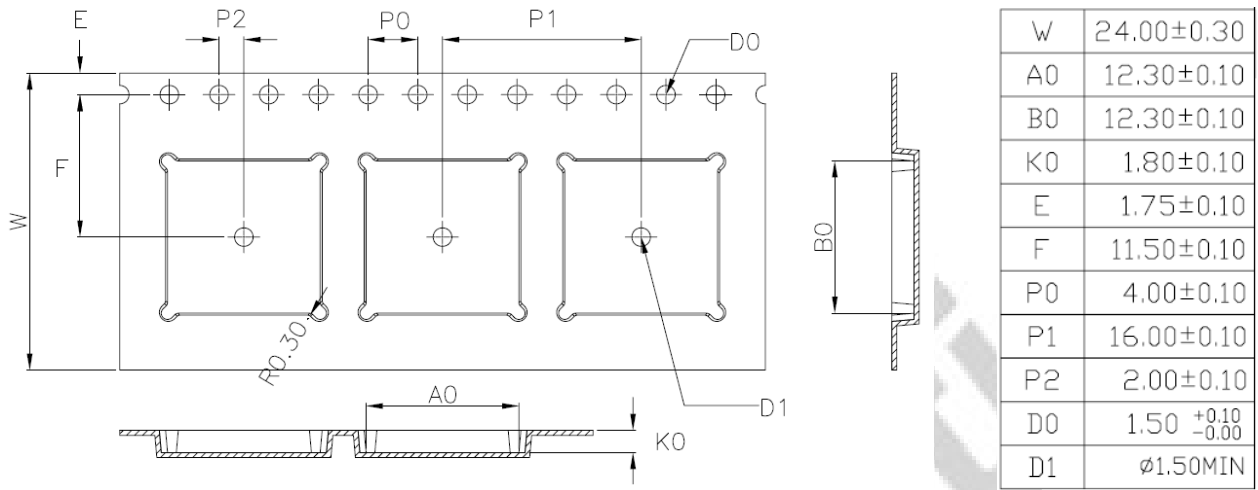

1. 10 sprocket hole pitch cumulative tolerance  $\pm 0.20$ .
2. Carrier camber is within 1 mm in 250 mm.
3. Material : Black Conductive Polystyrene Alloy.
4. All dimensions meet EIA-481-D requirements.
5. Thickness :  $0.30 \pm 0.05$  mm.
6. Packing length per 22" reel : 98.5 Meters.(1:3)
7. Component load per 13" reel : 1500 pcs.

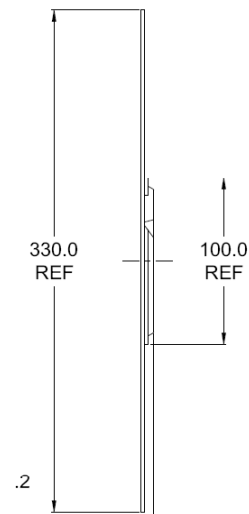
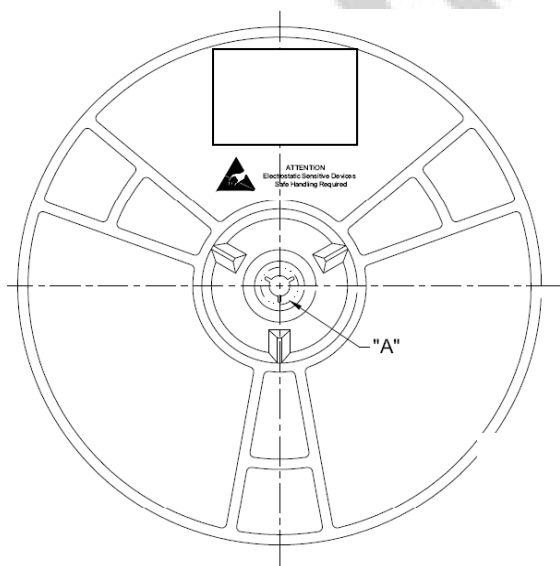

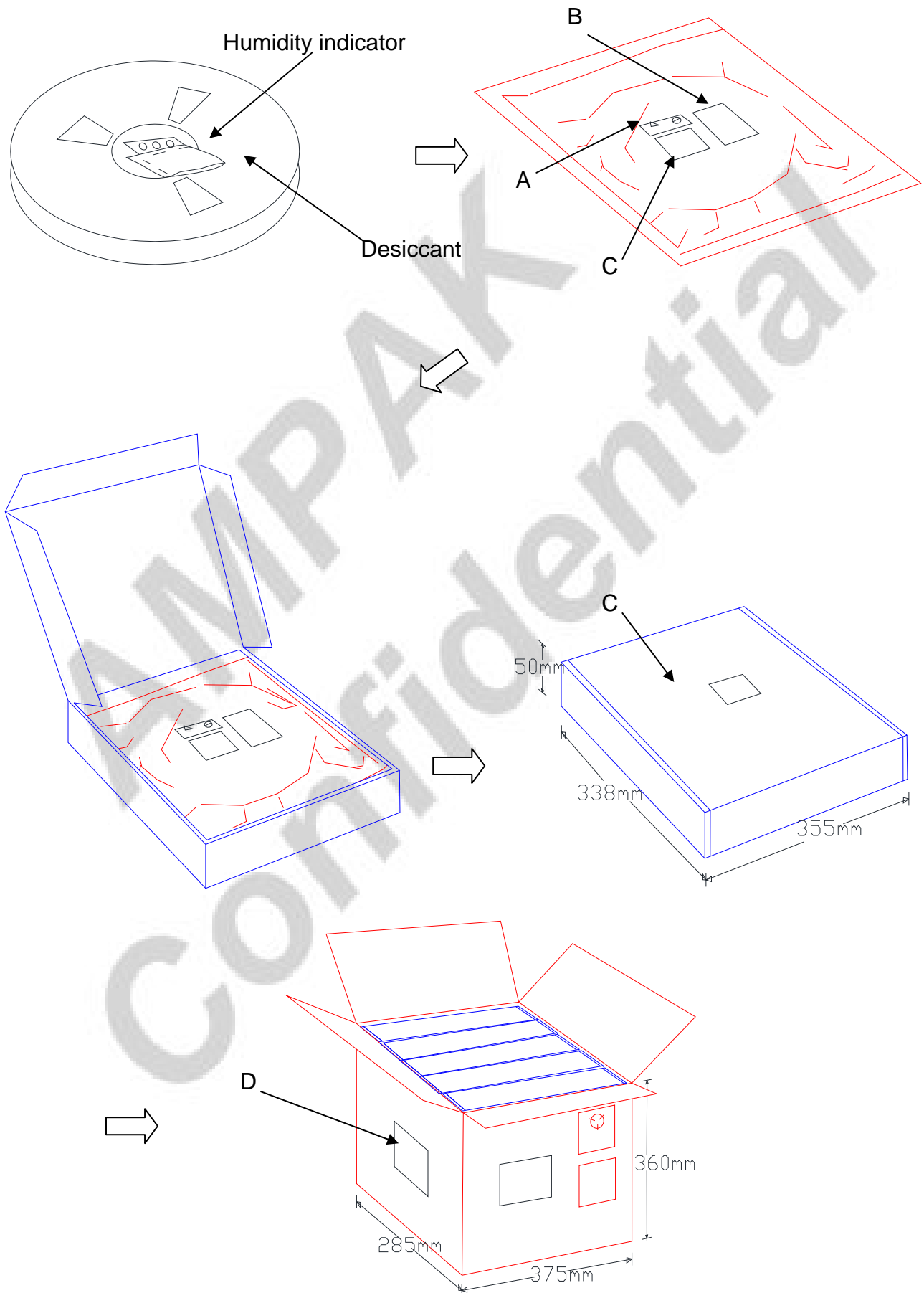

### 10.3 MSL Level / Storage Condition

	<p><b>Caution</b> This bag contains <b>MOISTURE-SENSITIVE DEVICES</b></p>	<p>LEVEL <b>4</b></p>
<p>Do not open except under controlled conditions</p>		
<p>1. Calculated shelf life in sealed bag: 12 months at &lt;math&gt; &lt; 40^{\circ}\text{C}&lt;/math&gt; and &lt;math&gt; &lt; 90\%&lt;/math&gt; relative humidity(RH)</p>		
<p>2. Peak package body temperature:      225<math>^{\circ}\text{C}</math>   240<math>^{\circ}\text{C}</math>   250<math>^{\circ}\text{C}</math>   260<math>^{\circ}\text{C}</math></p> <p style="margin-left: 100px;"> <input type="checkbox"/>      <input type="checkbox"/>      <input checked="" type="checkbox"/>      <input type="checkbox"/> </p>		
<p>3. After bag is opened, devices that will be subjected to reflow solder or other high temperature process must</p> <p style="margin-left: 20px;">a) Mounted within: 48 hours of factory conditions &lt;math&gt; &lt; 30^{\circ}\text{C}/60\%&lt;/math&gt; RH, OR</p> <p style="margin-left: 20px;">b) Stored at &lt;math&gt; &lt; 10\%&lt;/math&gt; RH</p>		
<p>4. Devices require bake, before mounting, if:</p> <p style="margin-left: 20px;">a) Humidity Indicator Card is &gt;10% when read at 23<math>\pm</math>5<math>^{\circ}\text{C}</math></p> <p style="margin-left: 20px;">b) 3a or 3b not met</p>		
<p>5. If baking is required, devices may be baked for 24 hours at 125<math>\pm</math>5<math>^{\circ}\text{C}</math></p>		
<p>Note : If device containers cannot be subjected to high temperature or shorter bake times are desired, reference IPC/JEDEC J-STD-033 for bake procedure</p>		
<p>Bag Seal Date:      <u>See-SEAL DATE LABEL</u></p>		
<p>Note: Level and body temperature defined by IPC/JEDEC J-STD-020</p>		

**※NOTE : Accumulated baking time should not exceed 96hrs**